

PRODUCT SPECIFICATIONS

MODEL NO.	MOTOR	RPM		AMPS		HP	kW	NET WT.		CAPACITOR	
		60HZ	50HZ	60HZ	50HZ			lbs.	kg	mfd.	VOLT
87R135-101R-N270X	100-120/200-240 (60Hz) 100-120/200-240 (50Hz)	1725	1425	2.6/1.4	3.5/1.9	1/4	0.19	14.9	6.8	30	370

SOUND LEVEL LESS THAN 65 db(A)

NORMAL AMBIENT +5 °C - +40 °C

RELATIVE HUMIDITY 20% - 80%

ENVIRONMENT CLEAN DUST FREE

NOTES:

1. TECHNICAL DATA SUBJECT TO CHANGE WITHOUT NOTICE.
2. THIS PUMP MUST BE INSTALLED IN AN ENCLOSURE.
3. ALL DIMENSIONS ARE FOR REFERENCE ONLY.
4. KIT P/N: K965A.

PRODUCT PERFORMANCE:

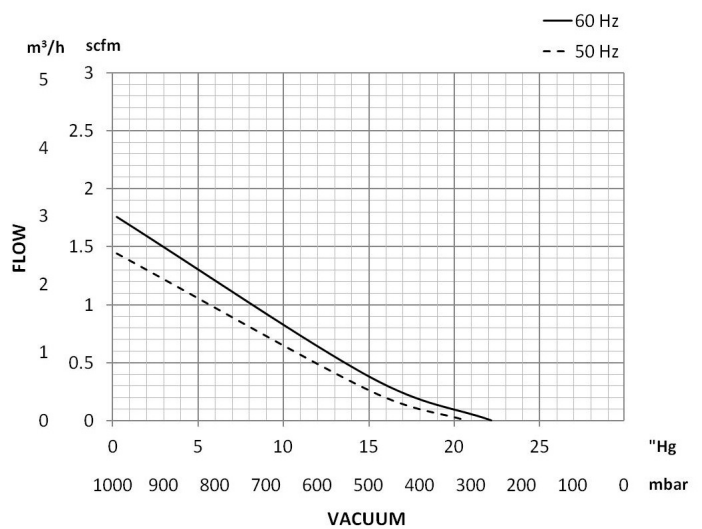
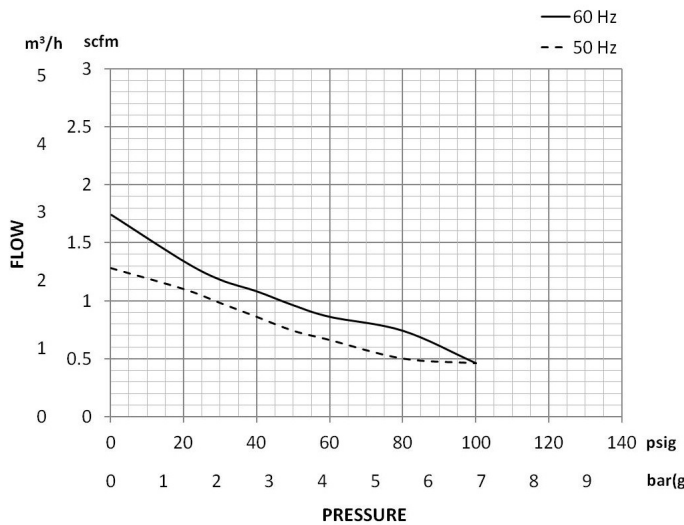

PRODUCT DIMENSIONS:

WIRING DIAGRAM

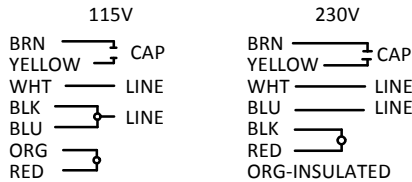

CAPACITOR MOUNTING KIT
TO BE SHIPPED UNATTACHED.

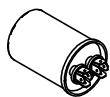
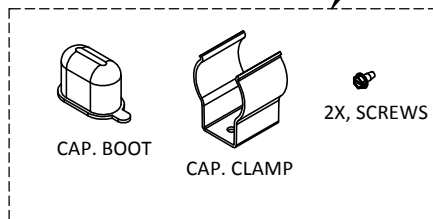

CAPACITOR TO BE SHIPPED UNATTACHED

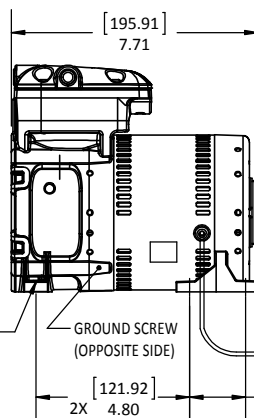
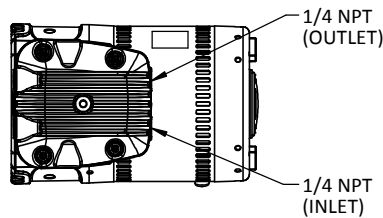

5X, MOTOR LEADS
#18 AWG. 29.0 ±1.0 LG.,
STRIPPED .374 ±.06.

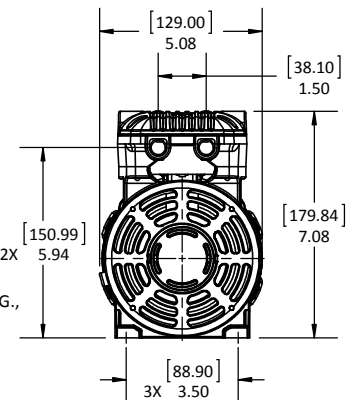

2X, MOTOR LEADS
#18 AWG. 29.0 ±1.0 LG.,
.032 x .250 FEMALE TERMINALS,
BRN & YEL LEADS (TO CAPACITOR)